

# TUNING EQUATIONS FOR CASCADED CONTROL SYSTEMS BASED ON THE FIRST ORDER PLUS DEAD TIME APPROACH

**Royman J. López Beltrán, M.Sc. M.E**

Universidad del Norte  
Km.5, Antigua vía a Puerto Colombia  
Barranquilla, Colombia  
rlopez@uninorte.edu.co

**Marco E. Sanjuán Mejía, Ph. D.**

Universidad del Norte  
Km.5, Antigua vía a Puerto Colombia  
Barranquilla, Colombia  
msanjuan@uninorte.edu.co

**Abstract.** The cascade control strategy is used in thermal and chemical processes to avoid the propagation of intermediate disturbances in the control loop. This technique measures an intermediate variable whose response to process disturbances can be observed earlier than in the controlled variable response. An internal or slave controller is implemented to establish an internal control loop in the intermediate variable. There are different methods to tune the internal PID controller, such as: quarter decay ratio, Dahlin tuning method and Lambda tuning, all of them based on off-line process identification as a FOPDT (First Order Plus Dead Time) model. To tune the Master or external controller a few tuning equations have been developed. The main sets of tuning equations were developed by V. Austin (1986) and Lee and Park (1998), but they operate in a narrow range of dynamic process parameters. M. Sanjuán (1999) found a set of equations to tune the master controller in PI – P and PID – P configurations. In this paper, we present a set of equations to tune the master controller as a Proportional Integral (PI) controller when the slave controller is either a PI controller or a P controller, based on FOPDT identification for the internal and external processes. These equations were obtained by running computer simulations of FOPDT processes in Matlab and Simulink and designing a three level factorial experiment. Performance evaluation is also carried out, comparing with Austin, Lee and Sanjuán tuning equations. These equations are valid for a wider range of process identified FOPDT parameters.

**Keywords.** Cascade control, PID, FOPDT, Master controller, Disturbance, Set Point.

## 1. Introduction

Automatic Process Control is an important engineering field in order to obtain better products and services to satisfy human necessities. In a lot of industrial processes, automatic process control variables is a technique used to maintain them in safe dynamic operation ranges. However, many variables are not handled by the control systems. These kind of inputs are called disturbances, and an efficient way to prevent the propagation of their effects through the process is by implementing a control strategy which compensates generating an stable response in process variables.

Feedback control is the most simple, inexpensive, and easy way to implement an automatic control strategy. The disadvantage of feedback control is, however, that disturbances must propagate through the process before the controller identifies the effect and starts to compensate for them. Hence, in order to reduce this effect, it can be implemented a cascade control loop, also called cascaded control strategy. It is very used in thermal and chemical processes to compensate the propagation effect of intermediate disturbances. But the main disadvantage of cascaded control strategy is the lack of equations to tune the parameters in the master controller. The process identification as a first order plus dead time (FOPDT) allows the implementation of a model which represents the process behavior in an efficient way. Using the FOPDT approach some tuning sets have been developed for master controllers in cascaded control architectures, however the dynamic ratios associated with process parameters have limited ranges, therefore the tuning methods do not work well in some cases. In this paper a newer developed set of tuning equations for cascaded control systems is presented. It was developed based on the FOPDT approach and it works in a wider range of process dynamics than current sets of tuning equations. The parameters defined to tune the master controller are: proportional gain, integral time and derivative time, based on a PID (proportional – integral – derivative) controller model. The main goal of this research is to establish a set of tuning equations for other controller architectures: PI in master controller and P in slave controller (PI-P), PI in master controller an PI in slave controller (PI-PI) and PID in master controller an P in slave controller (PID-P).

## 2. FOPDT Approach

A first order plus dead time dynamic model is identified by Fit 3 method for industrial processes. This method is based on the identification of three main process parameters: open loop gain, time constant and dead time. The open loop gain takes a measure of how input variables changes have effect in output variables. The following equation is a mathematical expression for an open loop gain:

$$K_p = \frac{\Delta O}{\Delta I} = \frac{\Delta \text{Output variable}}{\Delta \text{Input variable}} \quad (1)$$

The time constant shows the stability in the response for an step input in the set point. This method defines the time constant as the time to reach 63.2% of the total change in the system response. This process parameter has a direct relation with the stability and the speed of the process variable response. The slower the process response in open loop, the larger the time constant. The dead time is an indication of the transport delay of the output variable. It is produced by a delay time in the variable measurement generated by sensors and transducers.

$$\tau = \frac{3}{2}(t_2 - t_1) \quad (2)$$

$$t_0 = t_2 - \tau$$

where:

$\tau$ : Time constant

$t_0$ : Dead time

$t_1$ : Time at which 28.3% of total variable change occurs

$t_2$ : Time at which 63.2% of total variable change occurs

In order to describe the dynamic behavior of the process, we can define the system transfer function which models mathematically how changes the output variable for change in input variables. Also, transfer functions can be defined as the ratio of the Laplace transformed output variable to the Laplace transformed input variable. The transfer function completely defines the steady state and dynamic characteristics, or the total response, of a system described by a linear differential equation. Equation (3) describes the transfer function according to the first order plus dead time model used to identify industrial processes:

$$G(s) = \frac{K_p e^{-t_0 s}}{\tau s + 1} \quad (3)$$

### 3. Review of Tuning Equations

The first set of tuning equation for master cascaded controllers based on a single test was developed by Vanessa Austin (1986). These equations determine values of proportional gain, integral time and derivative time for master controllers in cascaded architectures for PID configurations. On Tab.(1) and Tab.(2) we can find the set of tuning equations for optimum tuning for disturbance changes and set point changes. Each one has specific ranges for dynamic ratios based on process parameters. The performance parameter used to develop this set of equations is the integral of the absolute value of the error (IAE).

Table 1. Tuning equations – Two level cascade system – for disturbance changes.

Master Controller	Slave Controller	P	PI	Range
PI	$\tau_{I1} = \tau_1$ $K_{cM}$	$1.4 \left[ \frac{1 + K_{c2} K_{p2}}{K_{c2} K_{p1}} \right] \left[ \frac{t_{01}}{\tau_1} \right]^{-1.14} \left[ \frac{\tau_2}{\tau_1} \right]^{-0.1}$	$1.25 \left[ \frac{K_{p2}}{K_{p1}} \right] \left[ \frac{t_{01}}{\tau_1} \right]^{-1.07} \left[ \frac{\tau_2}{\tau_1} \right]^{-0.1}$	$0.02 \leq \left( \frac{\tau_2}{\tau_1} \right) \leq 0.38$ $t_{02} \leq t_{01}$

Use this table if  $\tau_2/\tau_1 > 0.38$ . Otherwise, use table 2.

Table 2. Tuning equations – Two level cascade system – for set point changes.

Master Controller	Slave Controller	P	PI	Range
PI	$\tau_{I1} = \tau_1$ $K_{cM}$	$0.84 \left[ \frac{1 + K_{c2} K_{p2}}{K_{c2} K_{p1}} \right] \left[ \frac{t_{01}}{\tau_1} \right]^{-1.14} \left[ \frac{\tau_2}{\tau_1} \right]^{-0.1}$	$0.75 \left[ \frac{K_{p2}}{K_{p1}} \right] \left[ \frac{t_{01}}{\tau_1} \right]^{-1.07} \left[ \frac{\tau_2}{\tau_1} \right]^{-0.1}$	$0.02 \leq \left( \frac{\tau_2}{\tau_1} \right) \leq 0.65$ $t_{02} \leq t_{01}$

Where:

$K_{cM}$ : Master controller proportional gain

$K_{p1}$ : Outer loop process gain

$K_{p2}$ : Inner loop process gain

$\tau_{I1}$ : Master controller integral time  
 $\tau_1$ : Time constant of outer loop  
 $\tau_2$ : Time constant of inner loop  
 $t_{01}$ : Dead time of outer loop  
 $t_{02}$ : Dead time of inner loop

Other set of tuning equations was developed by Sanjuán (1999). These equations determine the values of proportional gain and reset time for master controller in cascade architectures with proportional controller in the inner loop and proportional – integral controller in outer loop. The expression to compute the value of the proportional gain follows:

$$K_{C1} = \left( \frac{1 + K_{C2}K_{p2}K_{r2}}{K_{C2}K_{p1}} \right) \frac{\tau_1}{(\lambda + t_{01})} \quad (4)$$

The value of the integral time is equal to the time constant in outer loop.  $\lambda$ , in equation 4, must be computed according to the following expression:

$$\lambda = \text{Max} \left( 3.836 - 2.332\tau_1 - 8.127\tau_2 + 9.303 \frac{\tau_2}{\tau_1}, 0 \right) \quad (5)$$

Another set of tuning equations available in the literature is the one developed by Lee and Park (1998). They developed a tuning set for master and slave controllers in control loops identified with the FOPDT model. This set of tuning equations is shown on Tab. (3).

Table 3. Lee and Park's tuning equations set.

	$K_C$	$\tau_I$
<b>Slave controller</b>	$\frac{\tau_I}{K_{p2}(\lambda_2 + t_{02})}$	$\tau_2 + \frac{t_{02}^2}{2(\lambda_2 + t_{02})}$
<b>Master controller</b>	$\frac{\tau_I}{K_{p1}(\lambda_1 + t_{01} + t_{02})}$	$\tau_1 + \lambda_1 + \frac{(t_{01} + t_{02})^2}{2(\lambda_1 + t_{01} + t_{02})}$

The terms  $\lambda_1$  and  $\lambda_2$  on Tab. (3) represent two constants which are used as parameters for adjusting the speeds for loop closed response. These parameters are given by:

$$\frac{\lambda_1}{(t_{01} + t_{02})} = 0.5 \quad (6)$$

$$\frac{\lambda_2}{t_{02}} = 0.5$$

To tune the slave controller in cases where the cascade tuning method does not specify an equation, Dahlin's Synthesis method is used. This method is characterized by a non aggressive closed loop response, according to the 5% overshoot criteria, a desirable behavior for self-regulated industrial processes . The tuning equation for a PI controller based on Dahlin's synthesis is:

$$K_{CE} = \frac{0.5}{K_p} \left( \frac{\tau}{t_0} \right) \quad (7)$$

Where:

$K_{CE}$ : Slave controller proportional gain

#### 4. Methodology to Generate the Tuning Equations Set

The methodology which was used to find this new equation set has the following steps:

- Development of a *Simulink* dynamic model based on the FOPDT approach in order to simulate the control system.
- Design and execution of an experiment in order to find the optimum values for each process parameters combination (unreplicated).
- Analysis of variance for collected data. From the data trend, the next step was to establish different equation models for controller tuning parameters.
- Fit through a non linear regression analysis the data with each model, and then, find the values for the constant parameters in each model.
- Choose the best models depending of how good the data fitted each one.
- Evaluation of the tuning equations set using computational examples of typical process models.

## 5. Simulink Dynamic Model

Computational models with externally adjusted process parameters were developed in order to carry out every experimental condition. The internal and overall loops were modeled using a FOPDT model. The following expression show the transfer function for internal and overall loop:

$$G_{p1}(s) = \frac{k_{p1}e^{-t_{01}s}}{\tau_1s + 1}, G_{p2}(s) = \frac{k_{p2}e^{-t_{02}s}}{\tau_2s + 1} \quad (8)$$

The disturbance was represented as a first order model, without dead time, in order to obtain quick propagation of it effect in the control loops. The disturbance transfer function is the follows:

$$D(s) = \frac{k_d}{\tau_d s + 1} \quad (9)$$

Where:

$K_d$ : Disturbance gain

$\tau_d$ : Time constant of disturbance

In Fig.(1), we can observe the cascade control architecture scheme. Based on that scheme the *Simulink* model was built up.

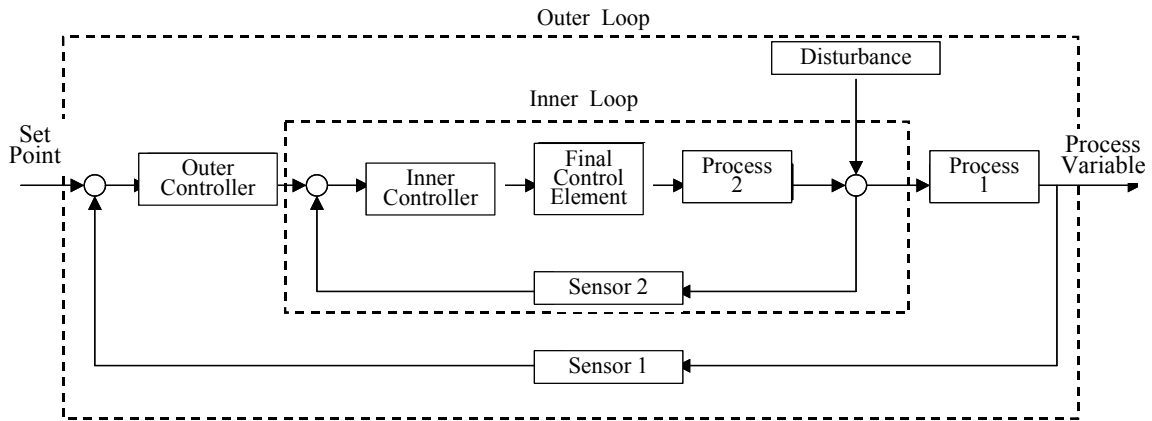

Figure 1. Cascade control architecture scheme.

## 6. Experimental Design

In order to establish the tuning equations for each cascade architecture (i.e. PI-P), an full factorial experiment was designed and implemented. A constrained function minimization was incorporated to each experimental condition, to obtain the optimal tuning parameters for each process parameters combination. A performance parameter (OP) was defined based on the Integral of the Absolute value of the Error (IAE) and the Integral of the Manipulated Valve signal (IMV). The expression for this term is:

$$OP = \int_0^{\infty} |e(t)| dt + \Gamma \int_0^{\infty} |m(t)| dt \quad (10)$$

$\Gamma$  in Eq. (10) represents the suppression factor, which measures the impact of IMV in the tuning performance. Optimal tuning at each experimental condition is defined as the set of tuning parameters with minimum IMV.

A three-level factorial experiment was chosen in order to observe linear and nonlinear correlation between process parameters and optimal tuning. Such experiment involves seven factors to produce 2187 runs for each controller architecture. No replicates were necessary, because this experiment is a deterministic computational test where repetition of factor levels will provide the same results. We did not use a fractional design to preserve the number of degree of freedoms and, therefore, the robustness of the experiment and the reliability of the equations obtained. In Tab.(4), we can observe the levels selected for each experimental factor. The response variable for the experiment were the optimal tuning parameters. The levels of each experimental factor were selected taking a wider range of dynamic process parameters than the other set of tuning equations.

Table 4. Dynamic process ratios used for the near-optimum value experiment.

Levels	$K_{p1}$	$\tau_1$	$t_{01}/\tau_1$	$K_{p2}$	$\tau_2/\tau_1$	$t_{02}/t_{01}$	$\Gamma$
Low	0.5	1	0.2	0.5	0.1	0.1	2
Medium	1.5	3	0.6	1.5	0.4	0.4	5
High	2.5	5	1.0	2.5	0.7	0.7	8

## 7. Experimental results

A Matlab subroutine was developed to run the experiment, using the Optimization and Statistic toolboxes available in release Matlab 6.1. To identify the most significant factors for the optimal tuning parameters, an ANOVA (Analysis of Variance) table was built for each tuning parameter (i.e.  $K_c$ ,  $T_i$ ) as response variable. For the analysis, only main effects and second-order interactions were taken into account. In Tab. (5) and Tab. (6) the ANOVA for master controller proportional gain and integral time, in PI-P controller architecture, are shown. In Tab. (7) and Tab. (8) the ANOVA for master controller proportional gain and integral time, in PI-PI controller architecture, are also shown.

Table 5. Summary of ANOVA table that includes the most significant factors in the master controller proportional gain response for the experiment in controller architecture PI-P.

Source	Sum. Sq	DOF	Mean Sq	Fo	P value
$k_{p1}$	4750.76	2	2375.38	87.40	0
$t_{01}/\tau_1$	36066.48	2	18033.24	663.51	0
$\tau_2/\tau_1$	329138.26	2	164569.13	6055.07	0
$t_{02}/t_{01}$	64817.05	2	32408.52	1192.42	0

Where:

DOF: Degree of Freedom

Fo: Test Statistic F

Table 6. Summary of ANOVA table that includes the most significant factors in the master controller integral time response for the experiment in controller architecture PI-P.

Source	Sum. Sq	DOF	Mean Sq	Fo	P value
$\tau_1$	1279.312	2	639.656	73.8626	0
$\tau_2/\tau_1$	260.5512	2	130.2756	15.0432	3.2616e-007
$t_{02}/t_{01}$	752.1878	2	376.0939	43.4285	0

Table 7. Summary of ANOVA table that includes the most significant factors in the master controller proportional gain response for the experiment in controller architecture PI-PI.

Source	Sum. Sq	DOF	Mean Sq	Fo	P value
$K_{p1}$	1548.9389	2	774.4694	11.5996	9.7759e-006
$\tau_1$	6669.4966	2	3334.7483	49.9459	0
$t_{01}/\tau_1$	5621.2146	2	2810.6073	42.0956	0
$\tau_2/\tau_1$	2710.0596	2	1355.0298	20.2948	1.8648e-009
$t_{02}/t_{01}$	3573.5995	2	1786.7998	26.7616	3.3422e-012

Table 8. Summary of ANOVA table that includes the most relevant factors in the master controller integral time response for the optimization experiment in controller architecture PI-PI.

Source	Sum. Sq	DOF	Mean Sq	Fo	P value
$\tau_1$	9817.9372	2	4908.9686	46.1565	0
$t_{01}/\tau_1$	8644.7692	2	4322.3846	40.6412	0
$\tau_2/\tau_1$	2710.0596	2	1355.0298	20.2948	1.8648e-009
$t_{02}/t_{01}$	3573.5995	2	1786.7998	26.7616	3.3422e-012

In the ANOVA table, the F value is used to distinguish the significant factors.  $F_0$  is the test statistic for the hypothesis of no differences in process parameters variances. The P value is an approach for decision making. This is related to the interval of confidence.

From Tab. (5) a tuning equation containing significant factor is proposed. The tuning equation in Eq. (11) is adjusted using non linear regression methods obtaining  $R^2=0.6966$ .

$$K_C = \frac{\tau_1}{8.2048K_{p1}t_{01}} \left( \frac{\tau_2}{\tau_1} \right)^{-1.3965} \left( \frac{t_{02}}{t_{01}} \right)^{0.2767} \quad (11)$$

From the Tab. (6) The same analysis was developed to find a model for integral time expression gives the next results. The model of Eq. (12) adjusts with a non linear regression 94% ( $R^2=0.9362$ ) the variability to predict new observations. Therefore, the master controller integral time, in PI-P controller architecture, is the follows:

$$\tau_I = \tau_1 \left( \frac{\tau_2}{\tau_1} \right)^{-0.0018} \left( \frac{t_{02}}{t_{01}} \right)^{0.2097} \quad (12)$$

From the Tab. (7) the model of Eq. (13) was found. It adjusts with a non linear regression 70% ( $R^2=0.7041$ ) the variability to predict new observations. Then the master controller proportional gain, in PI-PI controller architecture, is given by the next expression:

$$K_C = \frac{1}{2.4468K_{p1}} \left( \frac{t_{01}}{\tau_1} \right)^{-0.4485} \left( \frac{\tau_2}{\tau_1} \right)^{-0.3857} \left( \frac{t_{02}}{t_{01}} \right)^{-0.0995} \quad (13)$$

From the Tab. (8) the model of Eq. (14) was found. It adjusts with a non linear regression 73% ( $R^2=0.7250$ ) the variability to predict new observations. Then the master controller integral time, in PI-PI controller architecture, is given by the following expression:

$$\tau_I = 0.8693\tau_1 \left( \frac{t_{01}}{\tau_1} \right)^{0.4195} \left( \frac{\tau_2}{\tau_1} \right)^{-0.3022} \left( \frac{t_{02}}{t_{01}} \right)^{-0.1334} \quad (14)$$

The equations (11) to (14) composed the proposed Lopez and Sanjuan's set of tuning equations for PI-P and PI-PI cascade architectures for industrial self regulated processes. In Fig. (2) and (3) we can observe response surfaces of master controller proportional gain and master controller integral time for each architecture considered.

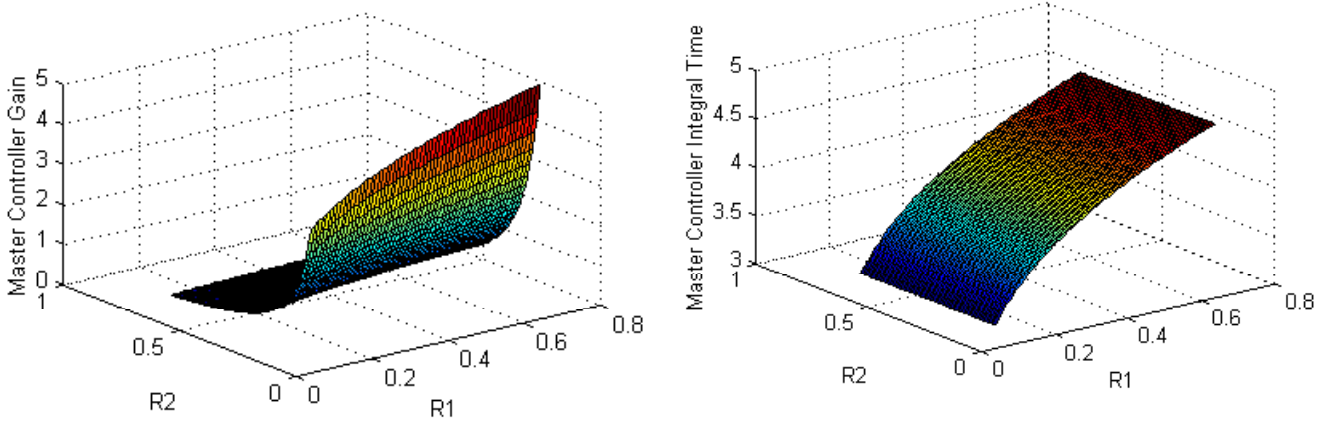

Figure 2. Response surfaces for master controller proportional gain and master controller integral time based on the tuning equations set found to PI-P cascade architecture.

Where:

$$R1 = \frac{\tau_2}{\tau_1} \quad R2 = \frac{t_{02}}{t_{01}} \quad (15)$$

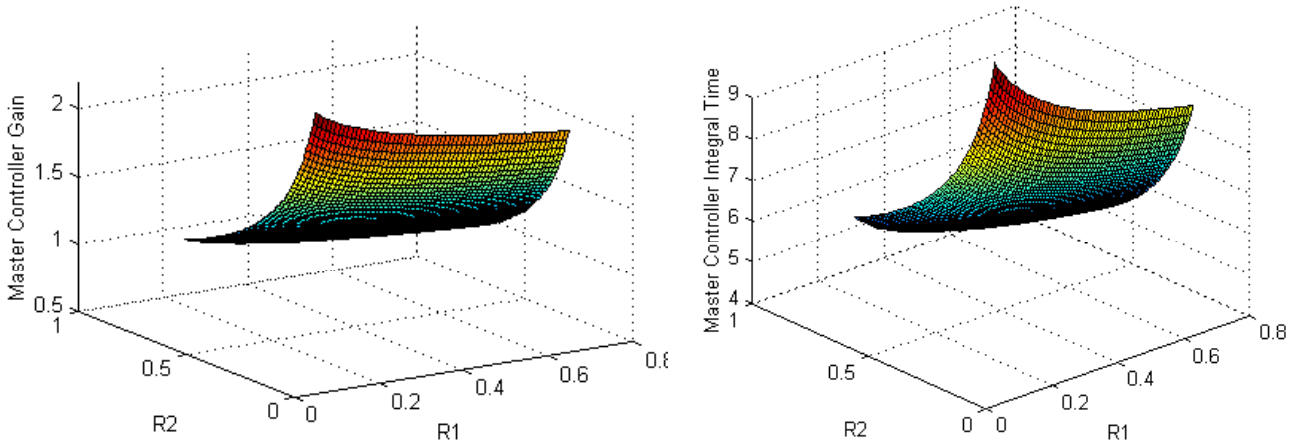

Figure 3. Response surfaces for master controller proportional gain and master controller integral time based on the tuning equations set found to PI-PI cascade architecture.

## 8. Performance evaluation

Two examples are given in this section to illustrate the performance of the proposed tuning method. The Lopez-Sanjuan set of tuning equations is compared with the tuning methods available in section 3 (Austin, Sanjuan, Lee and Park). Two performance criteria are going to be used : IAE and OP, defined by the authors in Eq. (11), using a suppression factor equal to 1 to give the same weigh to IAE and IMV.

### 8.1. Chemical Process

Since many chemical processes can be identified as FOPDT models, this example presents a process used by Lee and Park (1998) to evaluate the robustness of their tuning method. This example is going to be used to evaluate the proposed PI-P cascaded controller architecture tuning equation. The following transfer functions represents the inner and outer loops and the disturbance model:

$$G_{P1}(s) = \frac{10.2e^{-61.71s}}{66.49s + 1}, G_{P2}(s) = \frac{2.988e^{-3.66s}}{13.28s + 1}, D(s) = \frac{2}{s + 1} \quad (16)$$

Based on the transfer functions, the ranges of dynamic process parameter are the following:

$$\frac{t_{01}}{\tau_1} = 0.93 \quad \frac{\tau_2}{\tau_1} = 5.01 \quad \frac{t_{02}}{t_{01}} = 0.06$$

A step input of 5 units was implemented in the disturbance to analyze the performance when there is a disturbance. For set point changes, a 10% change of the steady-state value was made. In Fig. (4) and Fig. (5), respectively, the closed loop response for disturbance change and set point change of each controllers tuned with every equation considered is presented. In Tab. (9) the performance comparison of different tuning methods.

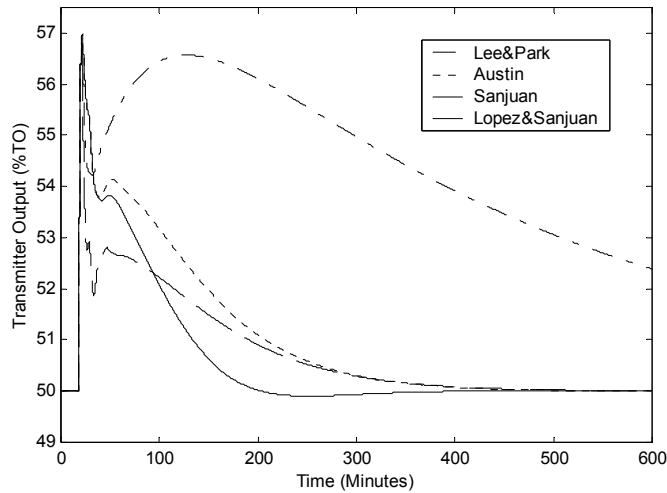

Figure 4. Process response for example 1, measured in transmitter output for a disturbance step change using a PI-P cascade control architecture.

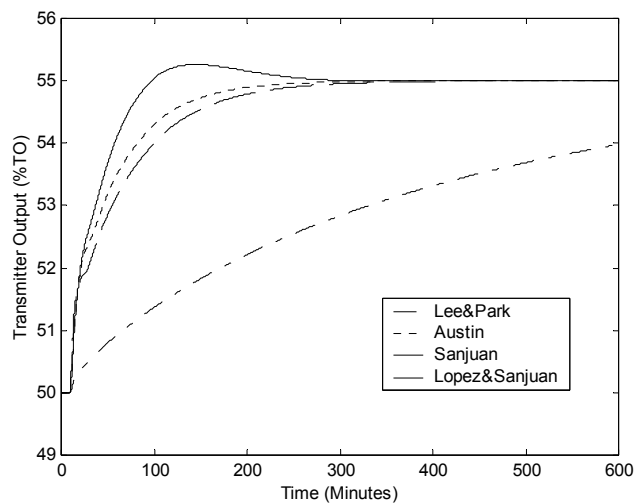

Figure 5. Process response for example 1, measured in transmitter output for a set point step change using a PI-P cascade control architecture.

Table 9. Performance comparison of different tuning methods.

Tuning Method	IAE disturbance	OP ( $\Gamma=1$ ) disturbance	IAE set point	OP ( $\Gamma=1$ ) set point
Austin	621.27	664.31	256.21	562.71
Sanjuán	454.69	516.08	308.53	609.89
Lee&Park	2715.37	2982.57	1538.77	1710
Lopez&Sanjuan	416.31	384.03	154.87	476.22

In Fig. (4) and Fig. (5) the process response for each tuning method is shown. It can be observed that the controller tuned with the proposed equation reaches steady-state faster. In addition, this behavior is accomplished with a good quantitative performance according with the criteria shown on Tab. (9). Considering only the minimum IAE criteria, the best performance is obtained by the proposed set of equations. If the OP parameter is used to compare, the best behavior is also obtained.



## 8.2. Thermal Process

This example was proposed by Semino and Bambrilla (1996), in order to test different parallel cascaded control schemes. We used this example to evaluate and to compare the performance of the proposed PI-PI cascade controller tuning method. The transfer functions are as follows:

$$G_{P1}(s) = \frac{1.24e^{-33s}}{30s + 1}, G_{P2}(s) = \frac{3.1e^{-9s}}{30s + 1}, D(s) = \frac{2.5}{15s + 1} \quad (17)$$

Based on the transfer functions, the ranges of dynamic process parameter are the following:

$$\frac{t_{01}}{\tau_1} = 1.0 \quad \frac{\tau_2}{\tau_1} = 0.27 \quad \frac{t_{02}}{t_{01}} = 1.1$$

A step input of 4 units was made in the disturbance to analyze the performance to disturbances changes. For set point variations, a change of 10% stationary state signal value in positive direction was realized. In Fig. (6) and Fig. (7), respectively, the closed loop responses for disturbance change and set point change of each tuning set are presented. In Tab. (10) the results of the evaluation for IAE and OP are shown.

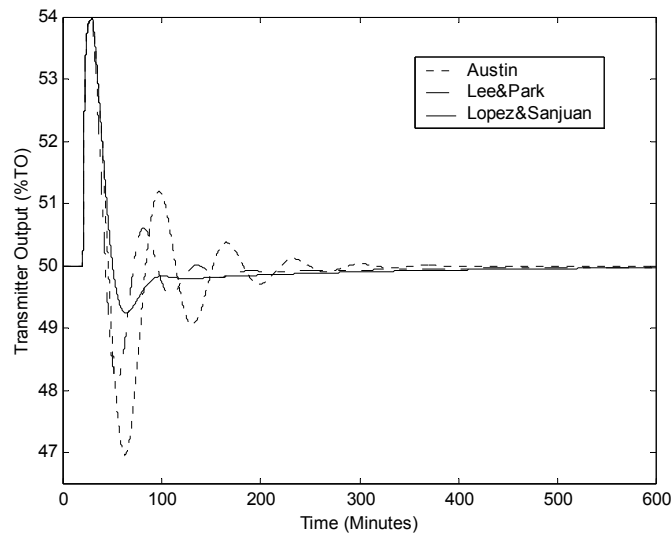

Figure 6. Process response for example 2, measured in transmitter output for a disturbance step change using a PI-PI cascade control architecture.

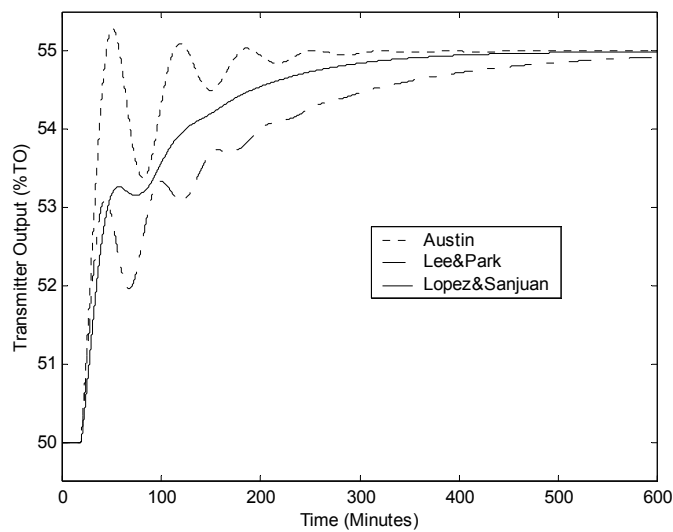

Figure 7. Process response for example 2, measured in transmitter output for a set point step change using a PI-PI cascade control architecture.

Table 10. Performance comparison of different tuning methods.

Tuning Method	IAE disturbance	OP ( $\Gamma=1$ ) disturbance	IAE set point	OP ( $\Gamma=1$ ) set point
Austin	206.95	586.59	229.65	456.20
Lee&Park	136.14	375.25	594.94	899.11
Lopez&Sanjuan	138.89	268.54	402.96	533.49

Fig. (6) and Fig. (7) show the process response using different tuning methods. It can be observed that the controller tuned with the proposed equation provides a non oscillatory response and reaches steady-state faster. Considering the minimum IAE criteria, for disturbance step change, the best performance is obtained by the proposed set of equations. If the OP parameter is used to compare, the best behavior is also obtained. Considering the minimum IAE criteria, for Set Point step change, Austin's response has the best quantitative performance, according to Tab.(10). Using the OP parameter, Austin obtain the best performance but with an small difference comparing with the proposed set of equations.

## 9. Conclusions

A new set of tuning equations for master controllers in PI-P and PI-PI cascaded architectures is presented in this paper. The tuning equations models are based on first order plus dead time identification of self-regulated processes. The main advantage of these equations is that they work in wider ranges of dynamics process FOPDT parameters than other tuning methods. Future research shall address the development of new sets of tuning equations for cascade architectures such as: PID-P, PID-PI and PID-PID. A deeper look to the effect of dynamic relations among inner and overall loop process parameters in cascade architecture performance should also be considered.

## 10. References

- Austin, V. ,1986, "Development of Tuning Relations for Cascade Control Systems," Ph.D. Dissertation, University of South Florida.
- Cunha, M., Guenter, R., De Pieri, E., De Negri, V.,2000, "A cascade strategy using non-linear control techniques applied to a hydraulic actuator". Proceedings of PPNI- PhD symposium. Hamburg.
- Kaya, I., 2001, "Improving performance using cascade control and a Smith predictor". ISA Transactions, Vol. 40, pp. 223-234.
- Krishnaswamy, P.; Rangaiah, G.,1987,"Tuning of Cascade Control Loops," Proceedings of the American Control Conference 1987, American Automatic Control Council, IEEE, 1158-1160.
- Krishnaswamy, P.; Rangaiah, G.; Jha, R.; Deshpande, P. ,1990, "When to Use Cascade Control," Industrial & Engineering Chemical Research, Vol. 29, No. 10, 2163-2166.
- Lee, Y., Park, S., Lee, M. ,1998, "PID controller tuning to obtain desired closed loop responses for cascade control systems". Ind. Eng. Chem. Res. pp. 1859-1865.
- Montgomery, D.,1997, "Design and Analysis of Experiments," John Wiley. New York.
- Sanjuán, M. ,1999, "Considerations about stability and control improvement in feedback systems when implementing cascade control". M. Sc. Dissertation. University Of South Florida. Tampa.
- Semino, D., Bambrila, A. ,1996, "An efficient structure for parallel cascade control". Ind. Eng. Chem. Res. pp. 1845-1852.
- Smith, C.; Corripio, A, 1997,"Principles and Practice of Automatic Process Control," Second edition. John Wiley: New York.
- Wolff, E., Skogestad, S.,1996, "Temperature cascade control of distillation columns". Ind. Eng. Chem. Res. pp. 475-484.

## 11. Acknowledges

The authors wish to thank UNIVERSIDAD DEL NORTE and COLCIENCIAS for the financial support that may possible this research.

## 12. Copyright Notice

The authors are the only responsible for the printed material included in their paper.