

## MIXED REALITY WITH HYPER-BONDS FOR MECHATRONIC DESIGN

**Heinz-H. Erbe**

Center of Human-Machine Systems, Technische Universität  
Berlin, Germany  
heinz.erbe@tu-berlin.de

**F. Wilhelm Bruns**

Artec Research Center, Universität  
Bremen, Germany  
bruns@artec.uni-bremen.de

**Abstract.** Research fields like Mixed Reality, Ubiquitous Computing, Embedded Systems and Cybernetics beside their special orientations; all deal with the problem how to connect real physical phenomena to virtual, computer internal control or simulation models. There are several well developed unified concepts to describe discrete and continuous physical processes (Petri-Nets, Bond-Graphs), however there is a gap between control theory and its application to general and easy to use human-machine interfaces. The concept of Hyper-Bonds, first demonstrated for quasi-static discrete event applications of pneumatic and electrical phenomena opens up promising perspectives to bridge the real and virtual world in a unified way. The paper presents the development of hyper bonds embedded in bond graph theory. Applications of discrete and continuous event driven systems explain the concept. Further developments using the hyper bond concept for collaborative engineering in future workspaces, where mixed reality features are promising tools, will be presented and discussed. Hyper bonds allow the transfer of force feedback, a desirable enrichment of collaborative work over remote sites.

**Keywords:** bond graph, mixed reality, hyper bond, simulation, collaborative engineering

### 1. Introduction

Mechatronics can be regarded as a methodology to achieve an optimal design of electromechanical products. The ideas and techniques developed during an interdisciplinary process provide the conditions to raise synergy and provide a catalytic effect for finding new and simpler solutions to traditionally complex problems. There is a synergy in the integration of mechanical, electrical, and computer systems with information systems for the design and manufacture of products and processes. The synergy can be generated by the right combination of features, that is, the final product can be better than just the sum of its parts. Mechatronic products exhibit performance characteristic that were previously difficult to achieve without this synergistic combination. Figure 1 shows key elements of mechatronic systems.

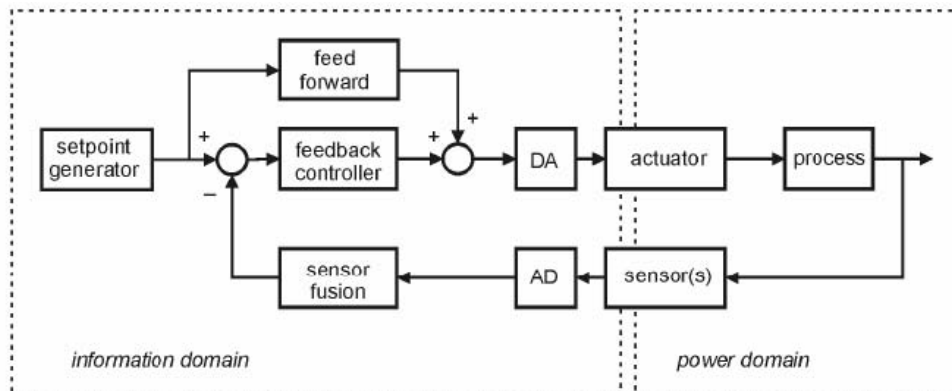

Figure 1. Key Mechatronic Elements (v. Amerongen, 2000)

In a conventional view, Mechatronics is the result of applying information technology to physical systems but in a more general way, it can be seen as the binocular view on systems, from a physical and an information perspective, which is the core of cybernetics. The physical system consists of mechanical, electrical, electronical and computer systems as well as actuators, sensors, and real time interfacing. The information part contains the logic and physics of control. With powerful microprocessors, real-time simulation of these systems play a more and more important role, allowing a free combination of real parts with simulated parts. This flexible mixture of real and virtual parts of a system, as a *mixed reality*, has some advantages not only for experiencing complex systems, but also for their design. Furthermore, a fast Internet makes it possible to have access to virtuality and reality in a distributed way, allowing the integrated use of remote laboratories. Mixed reality bridges the gap between the real and virtual world.

Most remote lab developments strictly separate reality and virtuality, energy and information. One can sense the remote process, view specific parameters, control the system by changing parameters and observe the process by video-cameras. The process, as a flow of energy controlled by signals and information is either in reality or completely modeled in virtuality and simulated. In the following paragraphs a distributed environment will be suggested where the process-model of energy and information flow can cross the border between reality and virtuality in an arbitrary bidirectional way. Reality may be the continuation of virtuality or vice versa. This bridging or mixing of reality and virtuality opens up some completely new perspectives not only for learning environments but also for evolutionary systems design and service work. To make this possible, Bruns (1999, 2001) developed a concept of Complex Objects being a unit of various closely coupled virtual and real representations and Hyper-Bonds, a universal interface type. This name has been chosen because of its relation to bond graph representations. Bond-Graph is itself a very powerful theory for studying dynamic systems.

## 2. Bond-Graphs and Hyper-Bonds

Bond graphs as a unifying view on physical phenomena from a continuity of power-flow perspective were introduced by Paynter (1961). Power flows through system components and connections by way that the product of effort and flow is continuous, following typical laws of energy conservation. Effort ( $e$ ) is the driving force for flow ( $f$ ) and can be a pressure difference, force and torque, electrical potential difference, temperature difference etc. Flow ( $f$ ) can be a flow of material, momentum, electric current, entropy. Figure 2 shows an example.

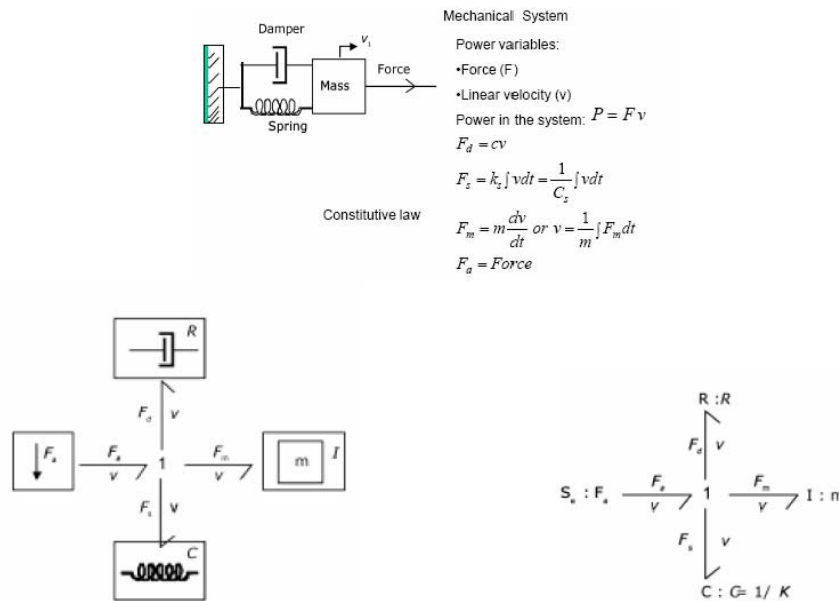

Figure 2: Examples of bond graphs (Shim 2002)

The bond graph theory has been further developed by Karnopp et al (1990), Mostermann (1997), and was used by v. Amerongen (2000) for modeling, simulation and controller design for mechatronic systems. Pairs of effort and flow ( $e, f$ ) are for example in mechanical systems force ( $F$ ) and velocity ( $v$ ), in electrical systems voltage ( $V$ ) and current ( $i$ ), in pneumatic/hydraulic systems pressure ( $P$ ) and volume flow rate ( $dQ/dt$ ). Figure 3 explains the correlation of pressure  $p$ , fluid flow  $q$  with force  $F$ , velocity  $v$  and mass/inertia  $I$ , compressibility  $C$  of the fluid and friction  $R$  in a simple pneumatic equipment. In many automation systems, electro-pneumatic circuits are considered as state automata and the elements can be represented as simple off/on switches like the valve and in/out positioning like the cylinder. These state automata do not require a bond-graph representation, but if one is interested in a more detailed dynamic behavior, then this can be described by graphs like the one in Figure 3.

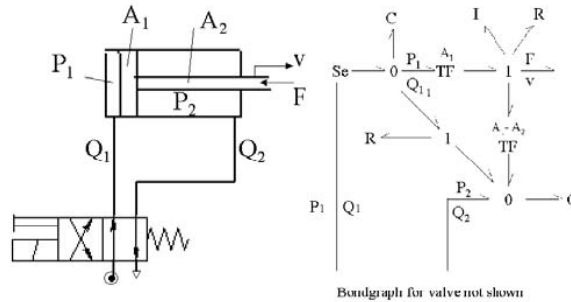

Figure 3. 4/2 valve controlling a double-acting cylinder

Components (valves, cylinders, etc.) are always connected by bonds having the value pair  $e$  and  $f$ . Knowing  $e$  and  $f$  at one connection, resulting from calculation or measurement, allows a cutting off of the system in two parts for a separate investigation. In order to provide arbitrary boundary conditions, we must have a mechanism to switch between a source of effort and a sink of effort, and to generate and sense phenomena. Figures 4 and 5 show the cutting boundaries between reality and virtuality and its realization with a special sensor/actuator coupling, called Hyper-Bond.

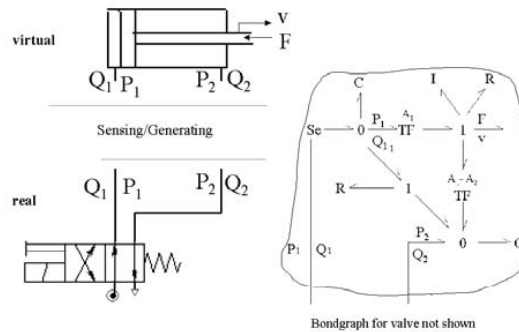

Figure 4. Cutting off the system of Figure 3 through a Hyper-Bond

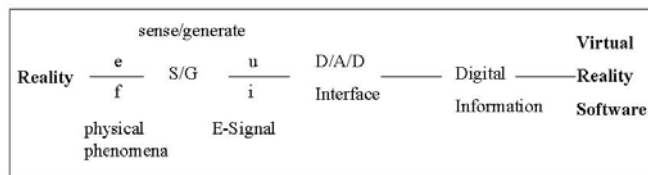

Figure 5. Hyper-Bond Structure

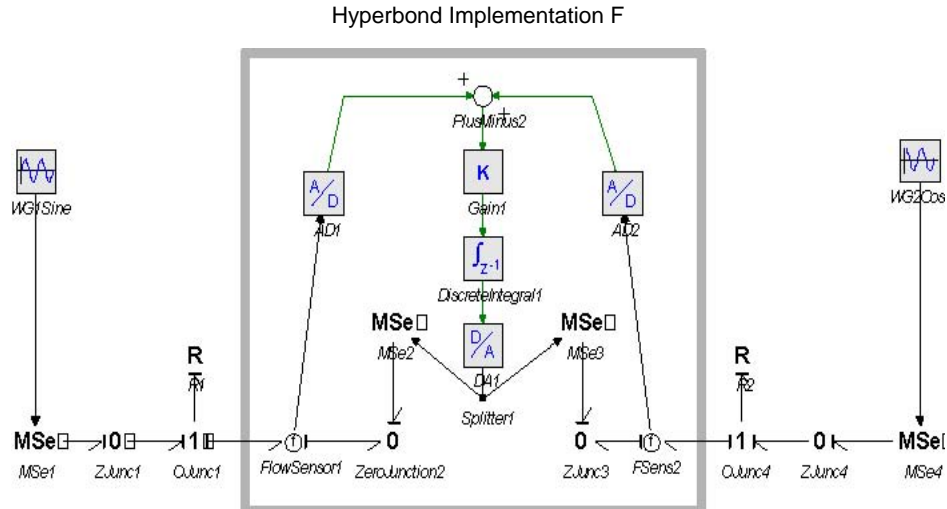

Figure 6. Hyper-bond implementation

A hardware implementation for a simple problem is shown in figure 6. For every supported physical phenomenon, there must be two sensors (pressure-meter and volume-flow meter for pneumatics) and a controllable source (air-flow and air-pressure). Analog sensor-signals are converted into digital values and then available for the software side of a hyper-bond. The opposite direction requires digital values from the software being converted into analog signals to drive a generating mechanism (force and speed for mechanics).

Hyper-bond is a mechanism based on the translation between physical effort/flow phenomena and digital information like any other analog/digital and digital/analog conversion, however it aims at a unified application oriented solution connecting the physical and its virtual representation and continuation. One of its main features is, that the modeler does not have to be aware about the direction of energy-flow, hyper-bonds are bi-directional and adapt itself to the environment conditions. Figures 4 and 5 are highly simplified presentations. For a deeper understanding of hybrid bond graphs and how to handle discontinuities, boundary cuts and transfer between power flow, signal flow and logic switches see Mostermann (1997).

Figure 7 shows an electro-mechanical system described by bond-graphs. The middle part can be modeled in virtuality to experiment with the belt transmission. An abstract view of the motor-belt-load system modeled with the simulator 20sim is presented in figure 8. Figure 9 shows a Hyper-bond connection, and figure 10 compared to figure 8 shows the conservation of the behavior. The controller design for such a motor-belt-load system depends on the transfer function of the whole system, which can be studied by the reaction of the open system on an impulse input. If all components are known in detail, this can be done on a theoretical level. Having unknown components, a distribution into virtuality and reality might be of some advantage.

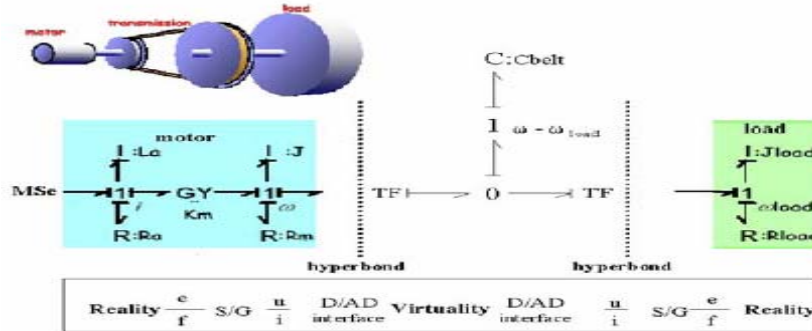

Figure 7. Bond Graphs of a DC-Motor and Belt-Transmission to a Load  
 (modified Figure 9 of Amerongen (2000))

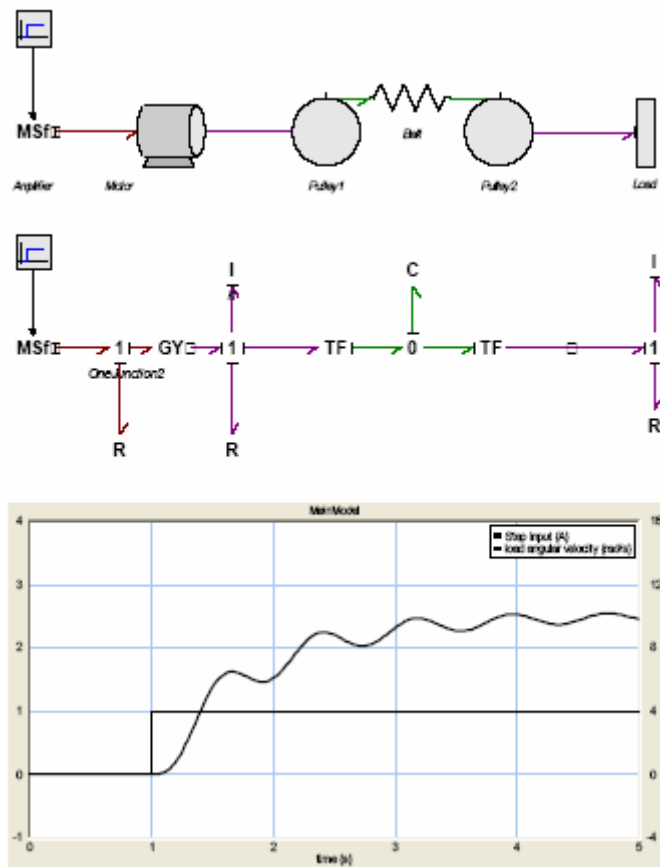
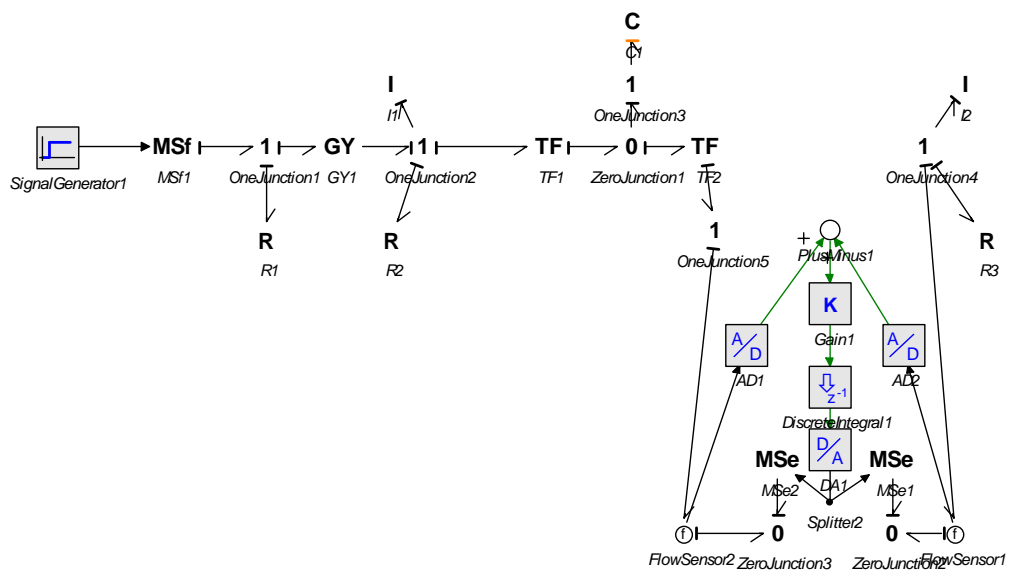

Figure 8. Behavior of an open loop system ( $c = 0.64 \text{ mm/N}$ )



20-sim3.5 Viewer (c) CLP 2004

Figure 9. Conserving behavior with Hyper-bond

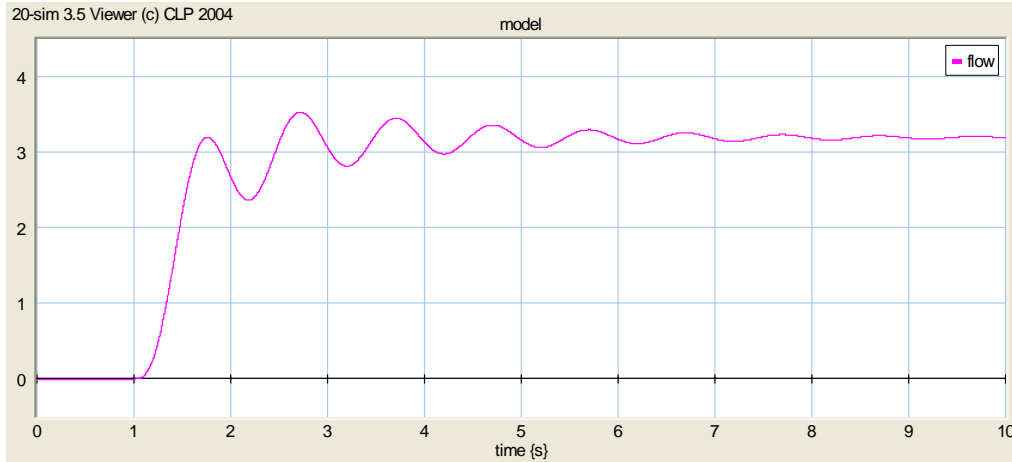

Figure 10. The Hyper-bond conserves the behavior compared to figure 8

### 3. Further Mixed Reality Examples

Realistic tele-presence requires feedback of information in multiple modalities of human perception: visual, auditory and haptic. Several solutions for tele-operation are reported in the literature. See for example the overview of Melchiorri (2003).

The reflection of the applied force to the environment on the remote site back to the operator is a requirement for an effective operation. Force feedback devices have been developed (Buss & Wollherr, 2003). Yoo, and Bruns (2004) proposed a low-cost momentum handle for force feedback (Fig. 11-12).

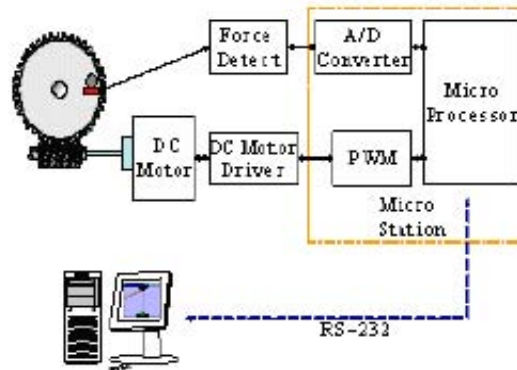

Figure 11 and 12. Map of the Momentum Handle and view

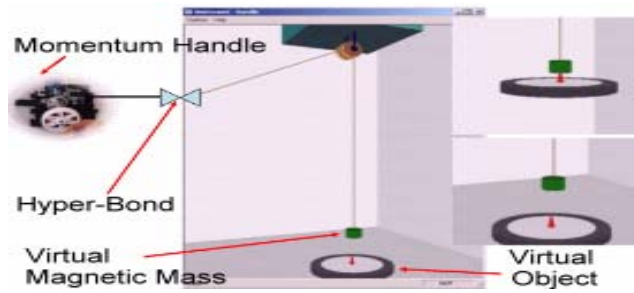

Figure 13. Mixed Reality Lifter Model with visual and force feedback

The handle, actively driven by a motor, is always in a momentum-equilibrium through the wheel with a virtual force/momentum. A pressure-sensor attached to the handle senses a force if the user applies a momentum. This analog signal is fed via an A/D-converter to a microprocessor. The microprocessor controls via a D/A-converter the motor driving the wheel. This micro controller is connected to a serial port of a PC, where it gets the virtual force/momentum from. As an example, Yoo and Bruns (2004) demonstrate the lift of a virtual mass represented by an algorithm of a program running at a PC (Fig. 13). Figure 14 shows the bond graph description.

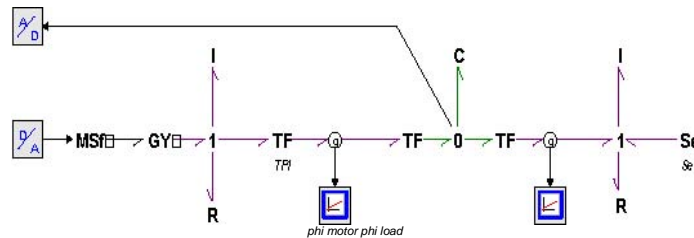

Figure 14. Bond graph description of the system of figure 13

At the “0”- junction the system has been cut off: left side reality, right side virtuality. Another interesting experiment regarding force feed back between remote sites has been shown by Yoo & Bruns (2004). A virtual mass at two computer screens of remote sites, connected through the internet, is moved through two momentum handles (Fig. 15). It is a consequent application of the concept of mixed reality.

While this research and development is not focused to distributed design and manufacturing but to tele-medicine and training, a haptic feedback would help bridging the physical separation of remote individuals. This feedback should range from reproducing the floor vibrations in response to a user walking about to the tactile response of a surgeon's instrument as it moves through different tissue.

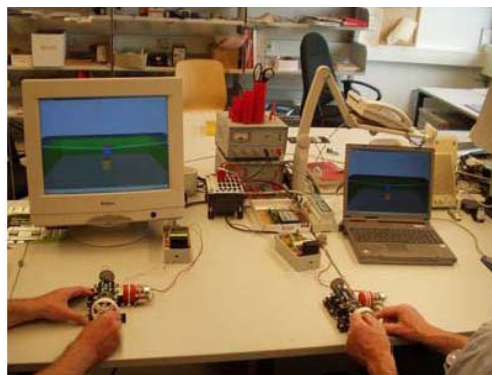

Figure 15. Moving a virtual mass with momentum handles at both remote sites providing force feed back.

#### 4. Conclusions

A new interface concept, allowing a flexible and user-friendly modeling in a blended real and virtual environment has been introduced. This concept, suitable for integration into the theory of bond-graphs, allows some learning and working modalities important for training and systems analysis: the stepwise abstraction and concretization of parts of a complex system still within the context of the whole. This feature supports various individual learning styles, systems diagnosis and repair strategies. Further developments and evaluations are undertaken in an EU-project [Lab@Future](#) where this interface technology is applied in concepts of future remote laboratories. The tele-cooperation functionality in the learning environment will allow enterprises to use the training facilities in order to update the knowledge of their employees. With new plant equipment being more complex and requiring more complex maintenance, the training requirements for workforce and engineers increases. The new environment will allow groups of employees at remote locations to take part at the same training using the same equipment (either simulated or real). These employees will be able to work in a collaborative way to solve problems and explore problems to be solved. This new kind of interaction provides a systematic support for skilled workers and engineers. Also, the environment is an appropriate tool to support collaborative engineering.

#### 5. References

- Amerongen, v. J., 2000, "Modeling, Simulation and Controller Design for Mechatronic Systems with 20-sim 3.0", Proc. 11th IFAC Conf. On Mechatronic Systems. Elsevier Ltd. pp. 831-836.
- Bruns, F. W., 1999, "Complex Construction Kits for Engineering Workspaces". In: Norbert A. Streitz et al: Cooperative Buildings. Lecture Notes in Computer Science 1670. Springer, Berlin, pp 55-68
- Bruns, F.W., 2001, "Hyperbonds - Enabling Mixed Reality. artec - paper 82, Bremen, <http://www.arteclab.uni-bremen.de//index.php>
- Bruns, F.W. et al, 2002, "DERIVE Final Report", artec-paper 102, Bremen <http://www.arteclab.uni-bremen.de//index.php>
- Bruns, F.W., Erbe, H.-H., 2003, „Didactical Aspects of Mechatronics Education”, Proc. SICICA 2003 - Intelligent Components and Instruments for Control Applications. L. Almeida, S. Boverie (eds.), Elsevier Ltd., Oxford
- Karnopp, D. C., Margolis, D. L., Rosenberg, R. C., 1990, "System Dynamics – A unified Approach", John Wiley, New York.
- Melchiorri, C. ,2003, Robotic Telemanipulation Systems: an overview on control aspects, Preprints of the 7<sup>th</sup> IFAC Symp. on Robot Control, Wroclaw, Poland.
- Mostermann, P. J. ,1997, "Hybrid dynamic systems: A hybrid Bond Graph Modeling Paradigm and its Application in Diagnosis", Dissertation, Vanderbilt University, Nashville, Tennessee
- Paynter, H. M., 1961, "Analysis and Design of Engineering Systems", MIT Press, Cambridge, MA.
- Shim, T., 2002, "Introduction to Physical System modeling using Bond Graphs", <http://www.umich.edu>
- Wollherr, D., M. Buss, 2003, "Cost-oriented virtual reality and real-time control system architecture", Robotica, Vol. 21, pp. 289-294.
- Yoo, J-H., F.W. Bruns, 2004, "Realtime collaborative mixed reality environment with force feedback", Preprints of the 7<sup>th</sup> IFAC Symp. On Cost Oriented Automation, Ottawa, Canada

#### 6. Responsibility notice

The authors are the only responsible for the printed material included in this paper.